

# EWH Beugel voor I-balken

**SIMPSON**  
**Strong-Tie**

**De universele en gemakkelijk te installeren EWH-beugel is ontworpen voor verschillende installatiemogelijkheden.**

De EWH-beugel maakt deel uit van de nieuwe generatie I-balkverbinders. De EWH-beugel kan worden gebruikt op houten en betonnen ondergronden, en biedt hierdoor veel installatie mogelijkheden, deze universele beugel kan worden gecombineerd met alle bevestigingen van Simpson Strong-Tie (CNA, CSA, SSH, WA ...).

## Voordelen:

Twee installatiemogelijkheden: boven- of zijflenzen,

- De bovenflenzen kunnen op de bouwplaats worden gevouwen op basis van de hoogte van de dwarsbalken,
- De bovenflenzen kunnen worden afgebroken, zodat de bevestiging alleen met de zijflenzen kan worden uitgevoerd,
- Optionele driehoekige boorgaten voor hogere prestaties,
- Messing aan de basis van de beugel om het uitlijnen van de dragers en spanwijdten van onderaf te vergemakkelijken.

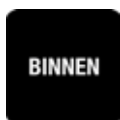

## Aanvullende bevestigingen:

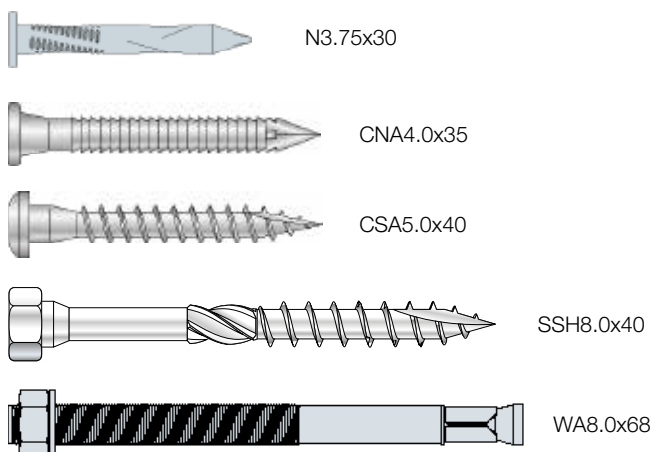

**Dit product  
vervangt de beugel  
IUSE**

Technische eigenschappen:

Artikelcode	Equivalentie IUSE	Afmetingen [mm]						Boorgaten			
								Flens B		Flens C	Flens E
		A	B	C	D	E	t	Ø 5,0	Ø 10,0	Ø 5,0	Ø 5,0
EWH200/47	IUSE199/48	47	200	49	80	40	0,9	8	4	4	4
EWH200/61	IUSE199/61	61	200	49	80	40	0,9	8	4	4	4
EWH200/91	IUSE199/92	91	200	49	80	40	0,9	8	4	4	4
EWH219/47	IUSE219/48	47	219	49	80	40	0,9	8	4	4	4
EWH219/61	IUSE219/61	61	219	49	80	40	0,9	8	4	4	4
EWH219/72	IUSE219/73	72	219	49	80	40	0,9	8	4	4	4
EWH219/91	IUSE219/92	91	219	49	80	40	0,9	8	4	4	4
EWH240/47	IUSE239/48	47	240	49	80	40	0,9	8	4	4	4
EWH240/50	IUSE239/50	50	240	49	80	40	0,9	8	4	4	4
EWH240/56	IUSE239/56	56	240	49	80	40	0,9	8	4	4	4
EWH240/61	IUSE239/61	61	240	49	80	40	0,9	8	4	4	4
EWH240/66	IUSE239/66	66	240	49	80	40	0,9	8	4	4	4
EWH240/72	IUSE239/73	72	240	49	80	40	0,9	8	4	4	4
EWH240/91	IUSE239/92	91	240	49	80	40	0,9	8	4	4	4
EWH240/99	IUSE239/100	99	240	49	80	40	0,9	8	4	4	4
EWH245/99	IUSE249/100	99	245	49	80	40	0,9	8	4	4	4
EWH295/99	IUSE294/98	99	295	49	80	40	0,9	8	4	4	4
EWH300/47	IUSE299/48	47	300	49	80	40	0,9	8	4	4	4
EWH300/50	IUSE299/50	50	300	49	80	40	0,9	8	4	4	4
EWH300/56	IUSE299/56	56	300	49	80	40	0,9	8	4	4	4
EWH300/61	IUSE299/61	61	300	49	80	40	0,9	8	4	4	4
EWH300/66	IUSE299/66	66	300	49	80	40	0,9	8	4	4	4
EWH300/72	IUSE299/73	72	300	49	80	40	0,9	8	4	4	4
EWH300/91	IUSE299/92	91	300	49	80	40	0,9	8	4	4	4
EWH300/99	IUSE299/100	99	300	49	80	40	0,9	8	4	4	4
EWH350/72	IUSE349/73	72	350	49	80	40	0,9	8	4	4	4
EWH350/99	IUSE349/100	99	350	49	80	40	0,9	8	4	4	4
EWH360/47	IUSE359/48	47	360	49	80	40	0,9	8	4	4	4
EWH360/61	IUSE359/61	61	360	49	80	40	0,9	8	4	4	4
EWH360/66	IUSE359/66	66	360	49	80	40	0,9	8	4	4	4
EWH360/91	IUSE359/92	91	360	49	80	40	0,9	8	4	4	4
EWH400/61	IUSE399/61	61	400	49	80	40	0,9	8	4	4	4
EWH400/91	IUSE399/92	91	400	49	80	40	0,9	8	4	4	4
EWH400/99	IUSE399/98	99	400	49	80	40	0,9	8	4	4	4

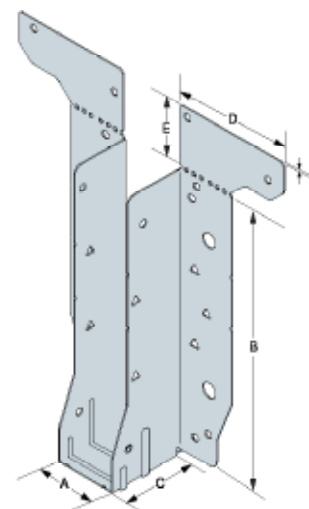

Voorbeelden van toepassingen:

Houten I-balk op houten I-balk

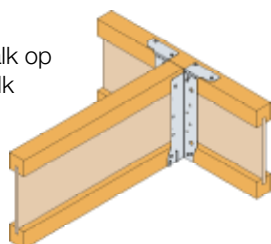

Stalen balk op stalen balk

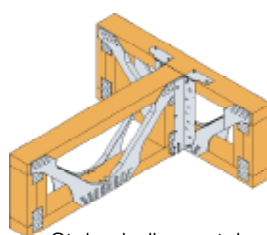

Massieve balk op stalen balk

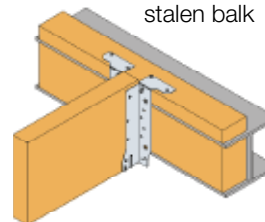

Houten I-balk op massieve balk

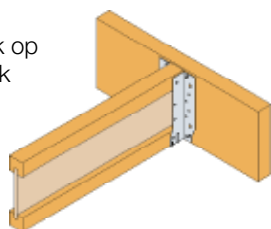

Massieve balk op geïsoleerd paneel (SIP)

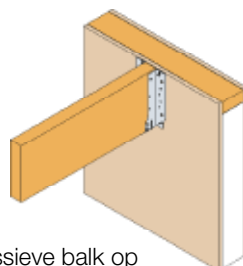

Massieve balk op beton

